

※L200用A¹→

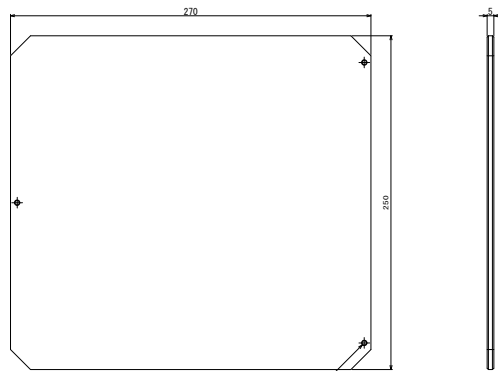

7837プレート

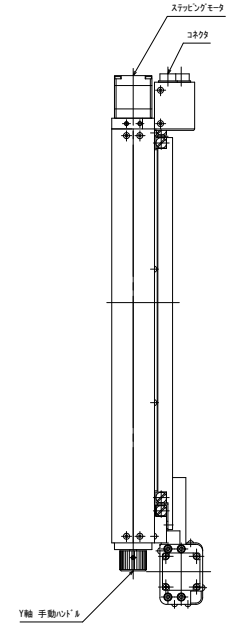
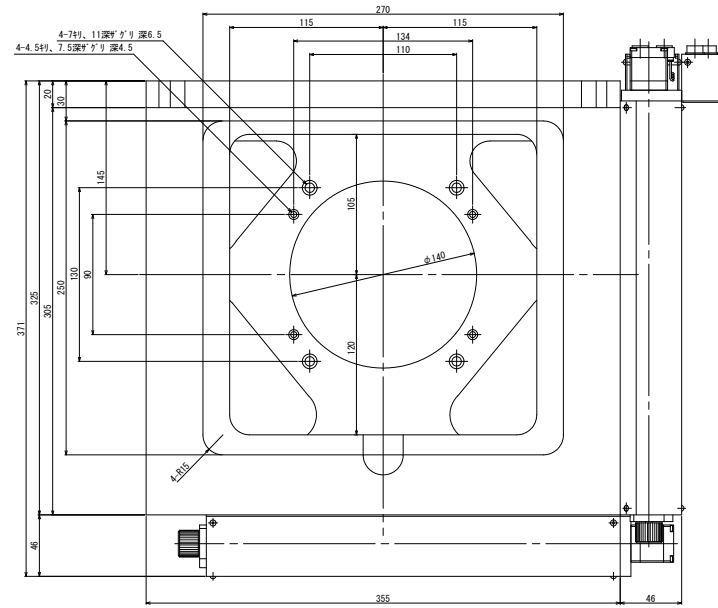
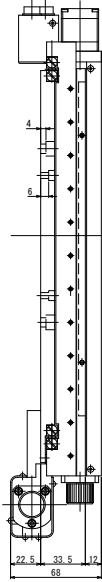
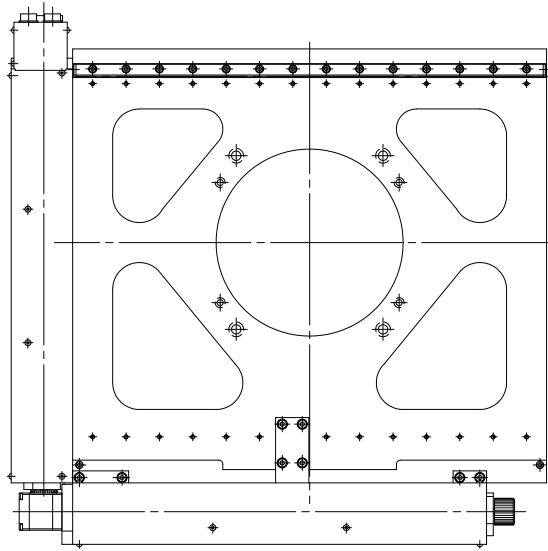
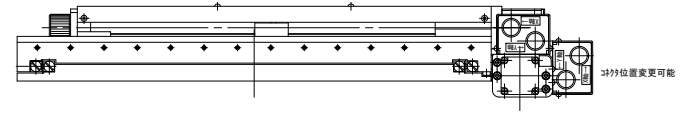
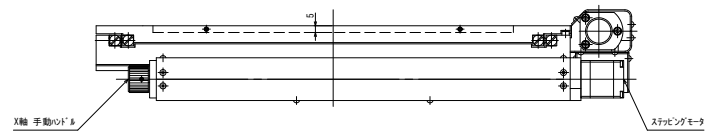

MSS-200D-NA
マイクロスキャンングステージ
中央精機株式会社